

Article number: 204050M1675A0U

Description: E+G levelling foot
GN 40-50-M16-75-A0-U

Note: U Without nut, Hexagon socket at the top, Wrench flat at the bottom

Measures

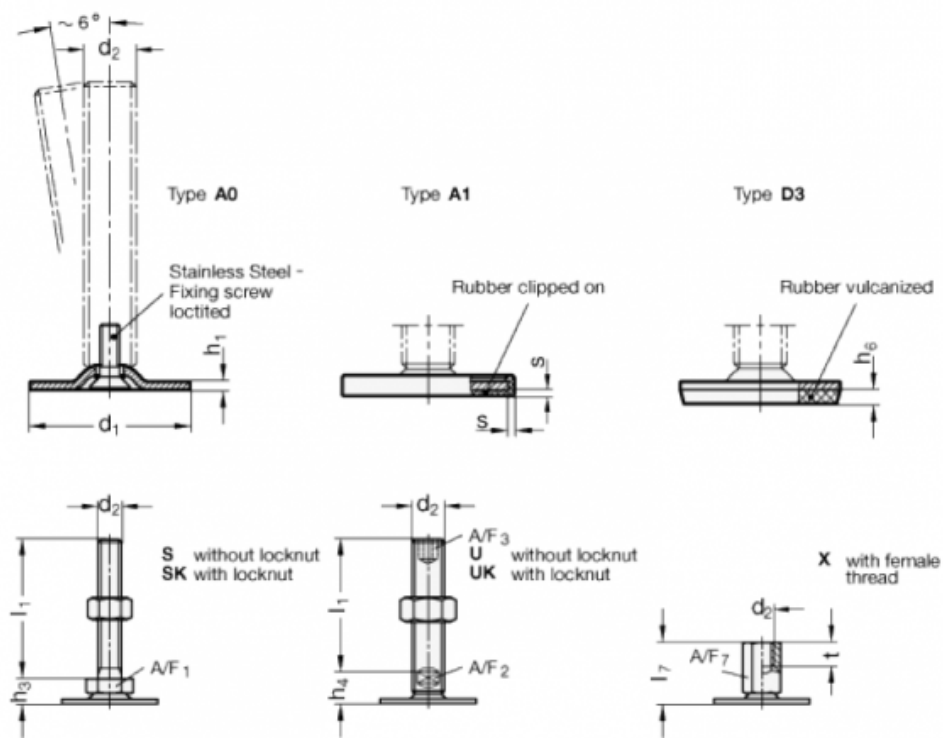

A/F2 = 12

A/F3 = 8

d1 = 50

d2 = M16

h1 = 2.5

h4 = 17

h6 =

l1 = 75

s =